

THESE DRAWINGS AND SPECIFICATIONS ARE THE SOLE PROPERTY OF ADVANCED CONNECTION TECHNOLOGY INC. AND SHALL NOT BE REPRODUCED, COPIED, OR USED IN ANY MANNER WITHOUT THE PRIOR WRITTEN CONSENT OF ADVANCED CONNECTION TECHNOLOGY INC. OR ITS AFFILIATED SUBSIDIARIES.

CAD FILE: XS07001-00A

REV.	DESCRIPTION	DWG		APPROVED	
		NAME	DATE	NAME	DATE
X01	PROTOTYPE	Peak	04/15/2009	Knight	04/15/2009
X02	MODIFY MIDDLE PIN	Peak	05/20/2009	Knight	05/20/2009

X02

- 1 ■ Functionally dim.
- 2 ◆ Assembly dim.
- 3 ● Control dim.

1

2

3

4

5

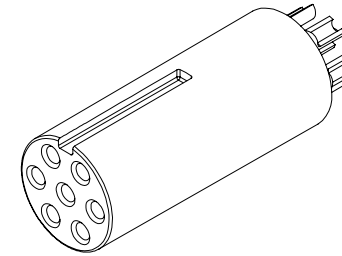
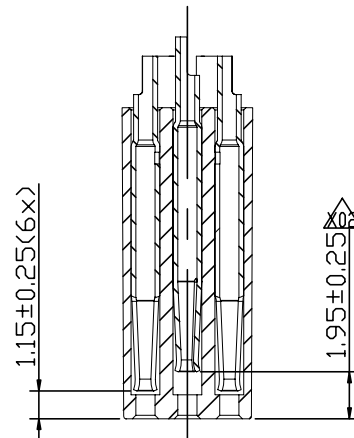
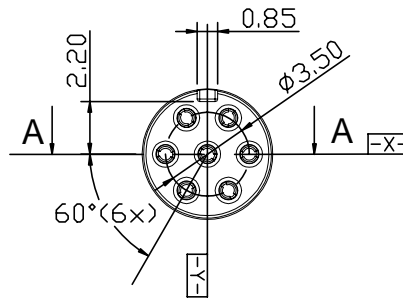
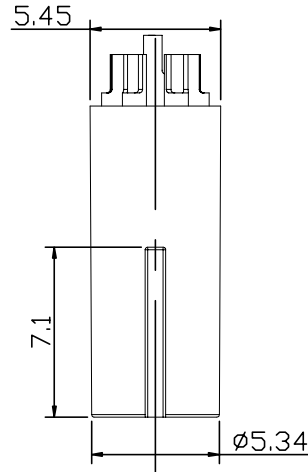
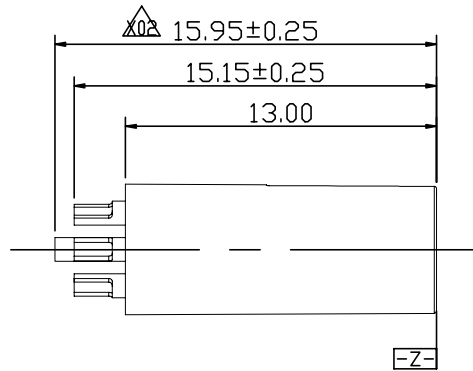

Note

1. Materials:

Housing: PBT+30%G.F.Black
Contact: Brass

2. Plating:

Contact: Ni under plating,
Sn on all area.

Approval Signature

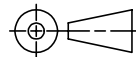
INTENDED USE: ACT		 Advanced Connection Technology TAIWAN TEL: 886-2-88091060			
GENERAL DIMENSION		TITLE: Mini Din 7Pins Female		DRAWN: Peak 05/20/2009	
Angle ±°2		DWG NO: 311-07001-00		CHECKED: Coco 05/20/2009	
.X±0.25 .XX±0.15		REV. X02		APPROVED: Knight 05/20/2009	
		UNIT: mm	SCALE: NONE	SHEET 1 OF 1	NAME DATE