

THESE DRAWINGS AND SPECIFICATIONS ARE THE SOLE PROPERTY OF ADVANCED CONNECTION TECHNOLOGY INC. AND SHALL NOT BE REPRODUCED, COPIED, OR USED IN ANY MANNER WITHOUT THE PRIOR WRITTEN CONSENT OF ADVANCED CONNECTION TECHNOLOGY INC. OR ITS AFFILIATED SUBSIDIARIES.

CAD FILE: S03040-07A

REV.	DESCRIPTION	DWG		APPROVED	
		NAME	DATE	NAME	DATE
AA	RELEASE	Roger	2010/06/21	Knight	2010/06/21
AB	ECN:DC1008004	Roger	2010/07/15	Coco	2010/07/15
AC	ECN:DC1009026	Sucre	2010/09/21	Coco	2010/09/21

- ◆ Assembly dim.
- Functionally dim.
- Control dim.
- [X] CPK DIMENSION

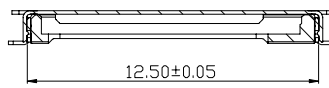
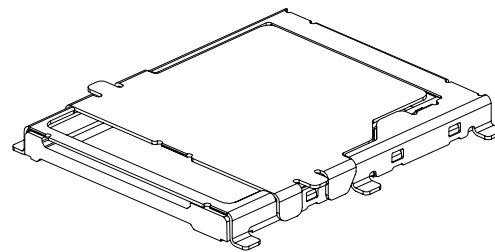
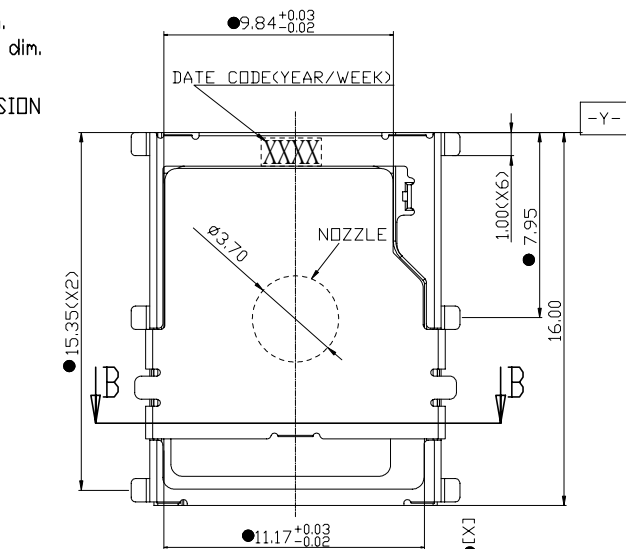

Section B-B

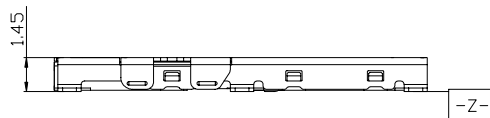
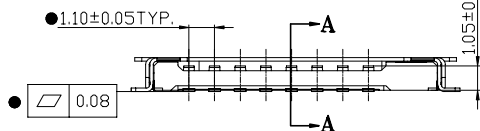

-Z-

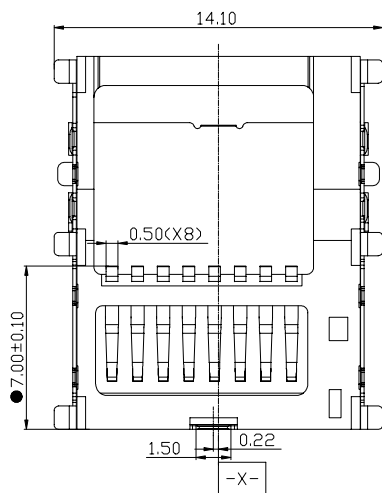

- MATERIAL:
 TERMINAL : COPPER ALLOY
 HOUSING : HEAT THERMAL PLASTIC
 UL94V-0 ,BLOCK GLASS FIBER FILLED
 SHELL : COPPER ALLOY
 COVER : STAINLESS STEEL
- FINISH:
 CONTACT: 15u*min Au PLATED IN CONTACT AREA.
 GOLD FLASH ON SOLDER TAILS(Au 1u*min)
 50u*Min. Nickel UNDERPLATED OVERALL

- Cover Retention Force:
 Initial:350g Min.
 After 3 cycles pick-and-place:300g Min.

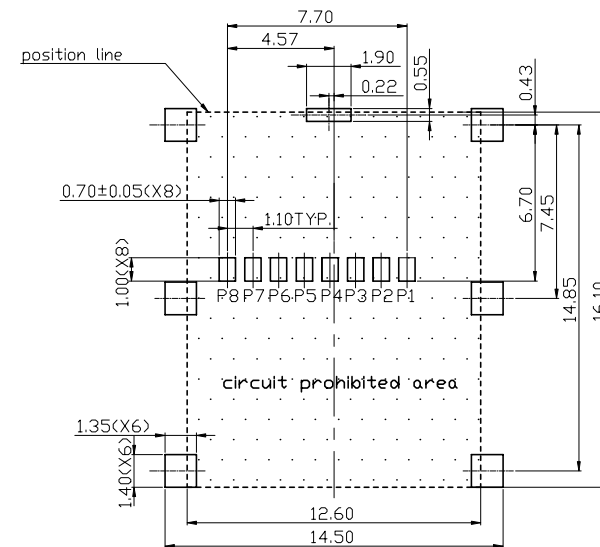

RECOMMENDED PCB LAYOUT
 GENERAL TOLERANCE ±0.05

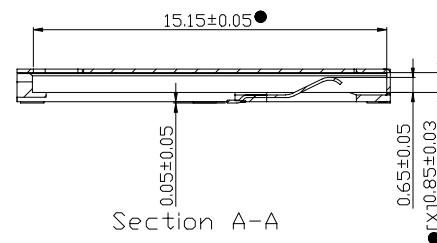

Section A-A

INTENDED USE: ACT		ACTT TAIWAN, R.O.C. TEL: 886-2-88091060			
GENERAL DIMENSION		TITLE: T-FLASH CONNECTOR H=1.45mm		DRAWN: Sucre	2010/09/21
XX±0.30	.X±0.15	DWG NO: 211-03040-07		CHECKED: Balon	2010/09/21
X±0.20	.XX±0.10	REV. AC	APPROVED: Coco	2010/09/21	
UNIT: mm		SCALE: 1:1	SHEET 1 OF 2	NAME	DATE

THESE DRAWINGS AND SPECIFICATIONS ARE THE SOLE PROPERTY OF ADVANCED CONNECTION TECHNOLOGY INC. AND SHALL NOT BE REPRODUCED, COPIED, OR USED IN ANY MANNER WITHOUT THE PRIOR WRITTEN CONSENT OF ADVANCED CONNECTION TECHNOLOGY INC. OR ITS AFFILIATED SUBSIDIARIES.

CAD FILE: S03040-07B

REV.	DESCRIPTION	DWG		APPROVED	
		NAME	DATE	NAME	DATE
AA	RELEASE	Roger	2010/06/21	Knight	2010/06/21
AB	ECN:DC1008004	Roger	2010/07/15	Coco	2010/07/15
AC	ECN:DC1009026	Sucre	2010/09/21	Coco	2010/09/21



- ◆ Assembly dim.
- Functionally dim.
- Control dim.
- [X] CPK DIMENSION

成品出料帶方向

1

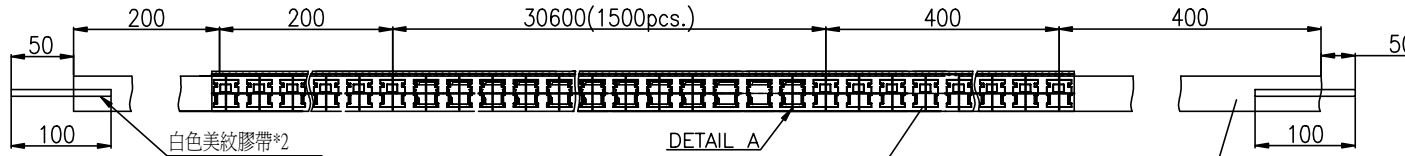

2

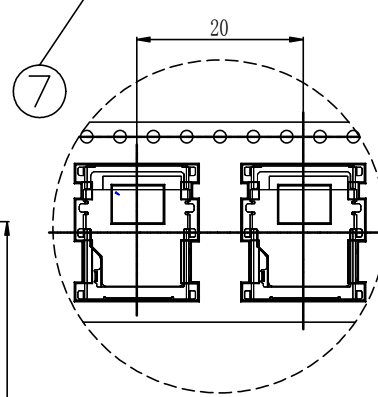

NOTES:

- 1. PACKING PREPARE LEADER AND EMPTY. DETAIL AS BELOW

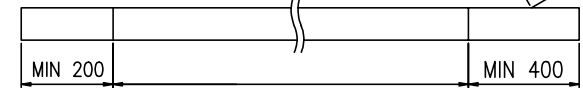

TAIL(EMPTY) WITH CONNECTOR LEADER(EMPTY)

- 2. FORCE OF TEARING OFF TOP TAPE 15~80 gf

TEARING OFF IN THIS DIRECTION

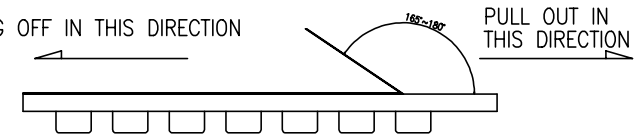

- 3. EDGE OF ROLLING UP SHOULD BE ADHERED THE TOP COVER TAPE TO THE SIDE OF REEL AN ADHENSIVE TAPE
- 4. TOP COVER TAPE SHOULD BE LIMITED IN AREA OF PLASTIC TAPE
- 5. PLASTIC REEL ---DIM A ϕ 330.2 DIM B ϕ 100
- 6. QUANTITY----PLASTIC REEL ABOUT 1500 PCS
- 7. CARRIER TAPE COLOR : TRANSPARENT.

3

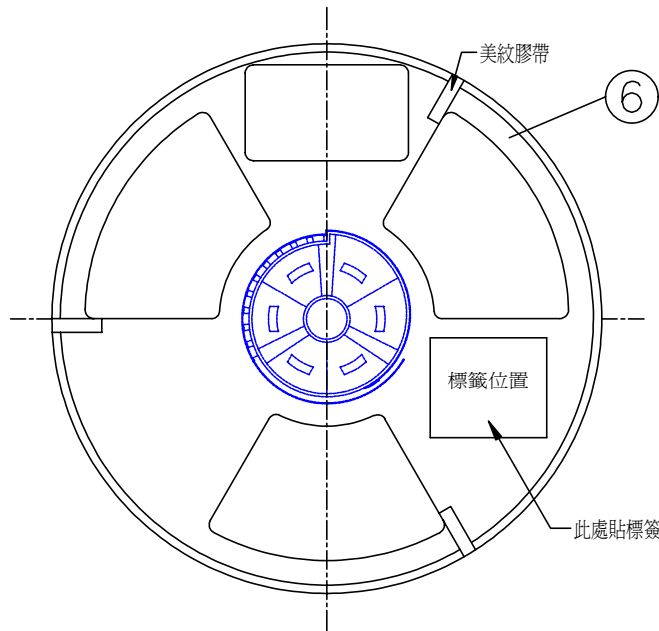

4

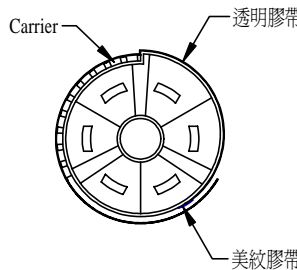

裝成品料帶方式

5

INTENDED USE: ACT		ACTT TAIWAN, R.O.C. TEL: 886-2-88091060			
GENERAL DIMENSION		TITLE: T-FLASH CONNECTOR H=1.45mm		DRAWN: Sucre	2010/09/21
XX \pm 0.15	X \pm 0.07	DWG NO: 211-03040-07		CHECKED: Balon	2010/09/21
X \pm 0.10	XX \pm 0.03	REV. AC	APPROVED: Coco	2010/09/21	
UNIT: mm		SCALE: 1:1	SHEET 2 OF 2	NAME	DATE